



5G WIFI DIGITAL MICROSCOPE INTERACTIVE SYSTEM

For Classroom & Laboratory

www.lanoptik.com



Content

System Overview	02
System Applications	03
System Composition & Diagram	04
Advantages & Benefits	05
Tutor-side Configurations	06
Student-side Configurations - Plan A	07
Student-side Configurations - Plan B	08
Student-side Configurations - Plan C	09
Student-side Configurations - Plan D	10
Student-side Configurations - Plan E	11
Student-side Configurations - Plan F	12
Specs of Student-side Cameras	13
EDU Software for Tutor PC	14
Tools in EDU Software	15
Imaging APP for Student-side Camera	16
Imaging APP for Mobile Devices	17
Accessories in the Box	18
Dimensions	19



Make Your Microscope Classroom Digital & Wireless

The system is for creating a true and stunning wireless microscope classroom and smart laboratory. Easily improve the quality of teaching and reduce the burden of laboratory management. Efficiently realize multi-functional interaction between teaching and learning.

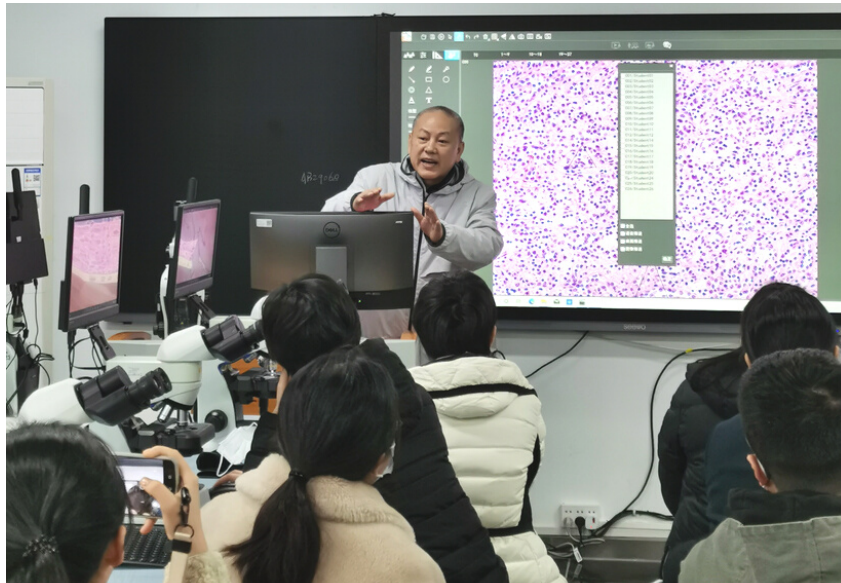

Build a Highly Efficient Teaching Ecosystem

Unleash the teaching and unfold it with one click

Three-foot podium, thousands of miles away. Whether it is a painstaking lesson plan or a real-time image under a microscope, it's transmitted to each student's smart mobile devices in one click, and the knowledge is no longer far away, completely solving the last mile of knowledge transmission.

Help students be more willing to learn and explore

Smartphones have changed everyday life and the way you look with a microscope. The microscope is no longer a cold optical device, it will become vivid and intelligent with the teaching system. To explore the micro world, have you ever seen the scene that students transmit images and discussions with their mobile phones during and after class?

Accurate color reproduction, showing the finest details

Do not boast of ingenuity in front of people. What can you do if the image loses true color. Without accurate color reproduction, resolution is worthless to a microscope. The camera insists on non-interpolation of images and frames, and truly restores each pixel, and makes every technical index of the camera have a lot of reliable data as the basis, which contributes to the sustainable development of microscope teaching activities and shows our respect for users.

Prospective configuration for the future

This will be a powerful tool for learning with microscopes. The best combination of optoelectronic hardware, software and APP will help you cultivate more pathologists, biologists and botanists ...

System Applications

The system is not only suitable for all kinds of teaching and experiment using microscope, but also can be used in interactive smart laboratory.



Life Science

The wireless microscope classroom system enhances for building smart morphology laboratories integrating anatomy, histology and embryology, and pathology, which helps to provide better morphology experiment teaching services. It is very suitable for basic medical education.



Earth Science

The experimental courses of earth science and geological science usually use polarized light microscope and stereo microscope. Through the 5G WiFi interactive system, teachers can quickly and efficiently cultivate students' ability to observe and identify rock, mineral and fossil specimens.



Materials Science

Microscopes are used in materials science and engineering to study the structure and properties of materials. Especially for metallographic subjects, metallurgy microscope and 5G WiFi interactive system can enhance students' learning of grain analysis, cast iron analysis, NMI, etc.



Forensic Science

Physical evidence technology, tool mark examination, document examination, etc. are the basic courses of criminal investigation and forensic medicine. With the 5G WiFi interactive system, teachers can effectively train students to master the skills of forensic inspection.

System Composition & Diagram

A real wireless system

This is an interactive system that enhance the teaching and learning in microscopy class via 5G WiFi camera system with PC and smart device. It is composed with a tutor-station and dozens of student-stations.

Tutor-station



- Tutor Microscope (trinocular)
- Interactive Workstation
- Computer (Win10/Win11)
- Monitor (FHD or 4K):

Student-station



- Student Microscope
- Microscope Camera: 1 pc
- Computer (Windows OS): (Plan C & Plan F)*
- Monitor: (Plan B, C, E, F)
- Tablet or smart phone: 1~2 units (optional)**

* Only for Plan C & Plan F (see page 8).

** The system of standard configuration allows two smartphones or tablets to be connected to each station, but as parts of the station, smartphones and tablets only display real-time microscopic images and do not have the interactive functions of the system. To ensure the stability and fluency of the system, as well as the convenience of management, we recommend using smartphones and tablets of the same brand and model.

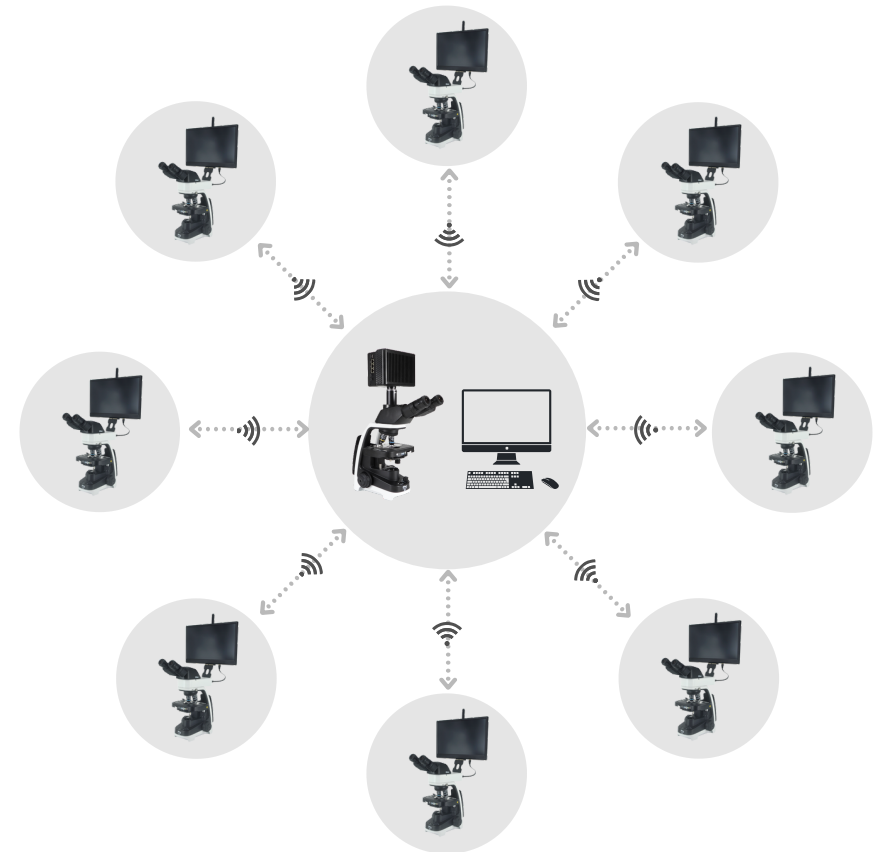

Advantages & Benefits

01



System self-built 5G WiFi LAN with high-speed transmission. WiFi signal covers a large area up to 10,00 square meters. No need to install driver and complicated setting. Plug and play, no need to modify the laboratory or classroom. No other cables except the power cord.

02



The system supports operating systems: Windows, iOS and Android. Excellent optical system and epoch-making wireless image transmission system are organically integrated. High resolution, high frame rate, accurate color reproduction.

03



The system provides student with all-in-one smart camera with 100% color gamut and 1080P 15.6-inch high definition displayer, which is easy to use and manage, and brings students an unprecedented visual experience.

04



The tutor has the highest-level administration authority to manage the system. The EDU software with nine modules of interactive functions guarantee the improvement of teaching efficiency, and guarantee the order in the class. (see page 15 'Interaction Settings')

05



The software and application provided by this system are original authorized and free to upgrade for product lifetime.

06



Integrated structure design, save desk space, only one power supply cord for a single student-station. Clean and neat, in line with the requirements of environmental protection.

07



Fully automatic distributed wireless networking. Simple installation, same-day acceptance. All stations in the system only need to be powered on to automatically build a 5G WiFi local area network.

08



Advanced microscopic image algorithm and the latest H.264 video stream encoding and decoding technology makes accurate color reproduction, low bit rate, low noise, high image quality, high speed preview at full resolution.

09



The most respected interactive software used in microscope classroom & Lab. Employs the most Cutting edge 5G WiFi technology. Automatically select smooth channels. A single system supports up to 120 stations

Tutor-side Configurations

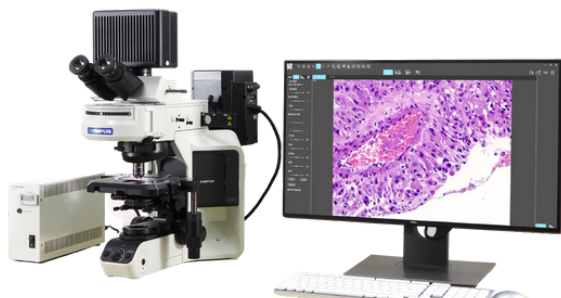

The teacher-station consists of a trinocular microscope equipped with an interactive workstation and a Windows-based computer. The interactive workstation is the backbone of the entire system, integrating a camera and a WiFi module. The lecturer controls the entire system through the dedicated software Pixit WiFi EDU installed on the teacher computer, and can interact with all stations at the same time, or select a specific station to interact. See page 14 for details on the Pixit WiFi EDU software.



1 Trinocular Microscope



2 Interactive Workstation

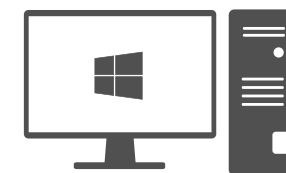

3 Teacher Computer

Specifications of Interactive Workstation

Applicable microscope	Olympus	Nikon	Leica	Zeiss	Olympus	Nikon	Leica	Zeiss
C mount	MW1200C	MW1200C	MW1200C	MW1200C	MW2000C	MW2000C	MW2000C	MW2000C
Dovetail mount	MW1200X	MW1200N	MW1200L	MW1200Z	MW2000X	MW2000N	MW2000L	MW2000Z
Resolution	12 MP (4000x3000 pixels)				20 MP (5184x3888 pixels)			
Image sensor	Sony IMX412 CMOS				Sony IMX147 CMOS			
Shutter type	Electronic rolling				Electronic rolling			
Sensor size	1/2.3"				1/2.3"			
Pixel size	1.55µm x 1.55µm				1.2µm x 1.2µm			
Spectral response	380~650nm				380~650nm			
Exposure	Real-time automatic, manual adjustment				Real-time automatic, manual adjustment			
White balance	Real-time automatic, manual adjustment				Real-time automatic, manual adjustment			
Preview resolution	30fps: 4000x3000, 3840x2160, 2592x1944, 1920x1080				10fps: 4000x3000; 15fps: 3840x2160			
Bit depth	12bit				12bit			
WiFi protocol	5G WiFi IEEE802.11ac				5G WiFi IEEE802.11ac			
Power input	DC 12V 5A				DC 12V 5A			
WAN type	Dynamic IP				Dynamic IP			
Software	Pixit WiFi EDU for Windows				Pixit WiFi EDU for Windows			

All-in-one Embedded Smart Camera

Plan A uses an all-in-one embedded smart microscope camera. The camera with dovetail mount is compatible with binocular microscopes from Olympus, Nikon, Leica and Zeiss. The camera comes with built-in operating system, the MS Office suite and microscope imaging software are pre-installed. The camera integrates a 15.6" full HD LCD display, which means that a student-station can be built without a dedicated computer and monitor. Each student-station only needs one power cord, no other cables. Plan A is easy to install, saves space and ensures a tidy tabletop. Read more about App for the student-station on page 16.

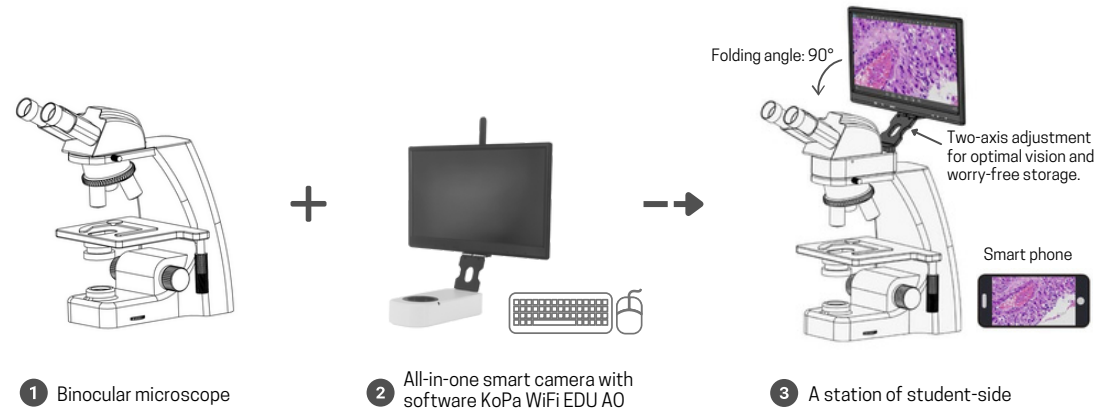

- ✓ The device is equipped with an all-in-one 15.6-inch with built-in deeply customized operating system. It comes with imaging APP, when starting up, it will connect with microscopic live image instantly and automatically.
- ✓ Embedded with 50:50 splitting prism, without destroying the original optical system.
- ✓ Built-in high-power reduction lens for large field of view.
- ✓ Accurate and simple focusing with screw rod, to realize parfocality.
- ✓ The USB ports can connect to mouse and keyboard, convenient for measuring, typing, and drawing.
- ✓ Supports HDMI out to monitor, TV, and projector. *
- ✓ Allows students to use their mobile phone or tablet to scan the dedicated seat QR code for wireless point-to-point connection to share live imaging.

* HDMI output is not available for all 20MP cameras (CMOS IMX147)

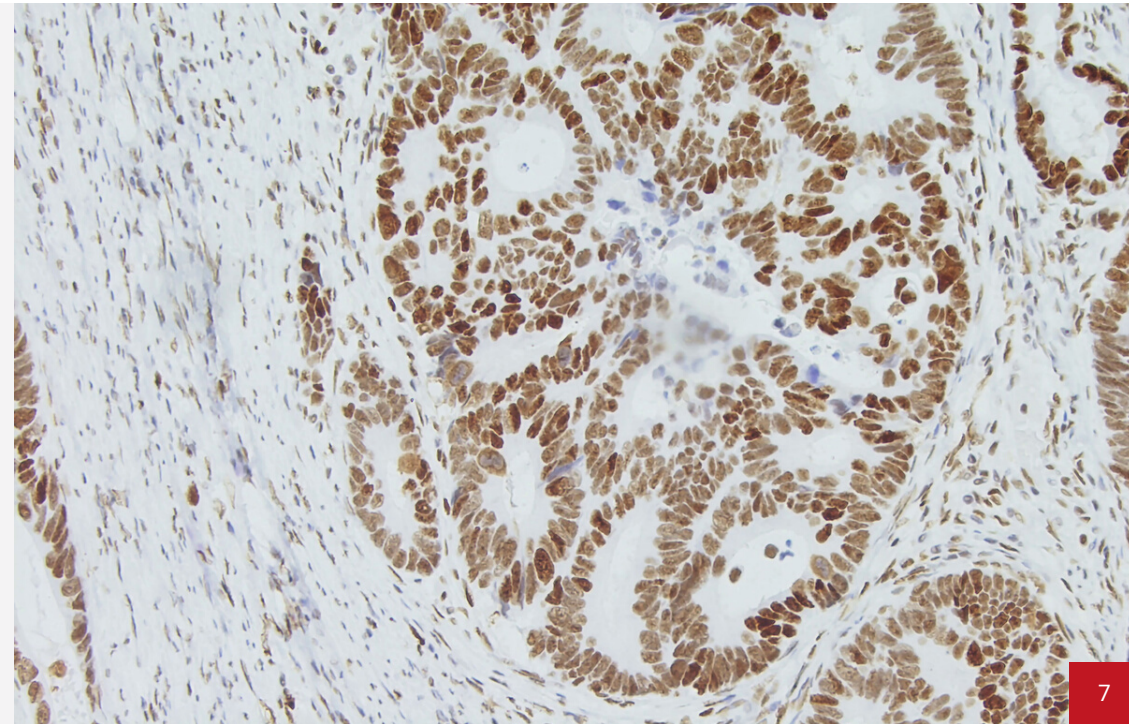

Embedded Smart Camera

Plan B uses an embedded smart microscope camera. The camera with dovetail mount is compatible with binocular microscopes from Olympus, Nikon, Leica and Zeiss. The camera comes with built-in operating system, the MS Office suite and microscope imaging software are pre-installed. Only one monitor is required to build a student station. Read more about App for the student-station on page 16.

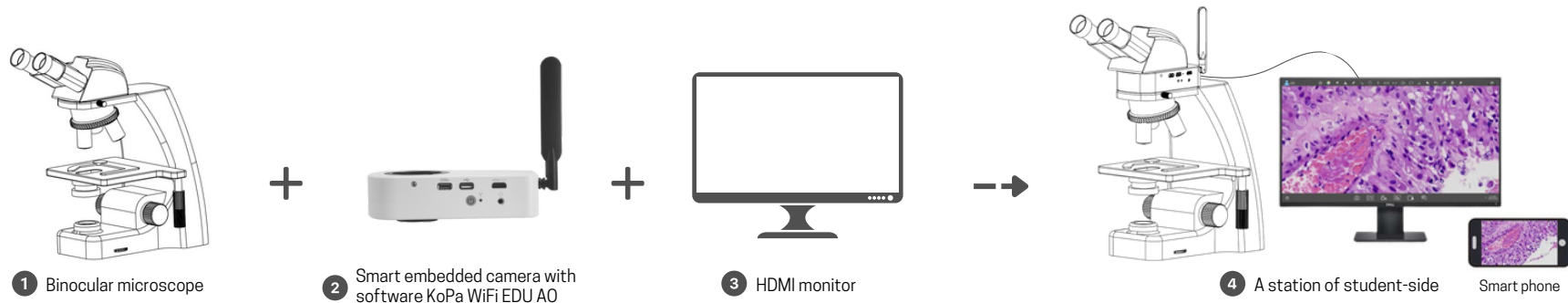

- ✓ The device is equipped with an all-in-one 15.6-inch with built-in deeply customized operating system. It comes with imaging APP, when starting up, it will connect with microscopic live image instantly and automatically.
- ✓ Embedded with 50:50 splitting prism, without destroying the original optical system.
- ✓ Built-in high-power reduction lens for large field of view.
- ✓ Accurate and simple focusing with screw rod, to realize parfocality.
- ✓ The USB ports can connect to mouse and keyboard, convenient for measuring, typing, and drawing.
- ✓ Supports HDMI out to monitor, TV, and projector. *
- ✓ Allows students to use their mobile phone or tablet to scan the dedicated seat QR code for wireless point-to-point connection to share live imaging.

* HDMI output is not available for all 20MP cameras (CMOS IMX147)



Embedded WiFi Camera

Plan C uses a WiFi microscope camera. The camera with dovetail mount is compatible with binocular microscopes from Olympus, Nikon, Leica and Zeiss. This plan supports Windows-based computers. On the premise of having a microscope with a WiFi embedded camera installed, the student-station only needs to be equipped with a computer and a monitor. Read more about software for the student-station on page 16

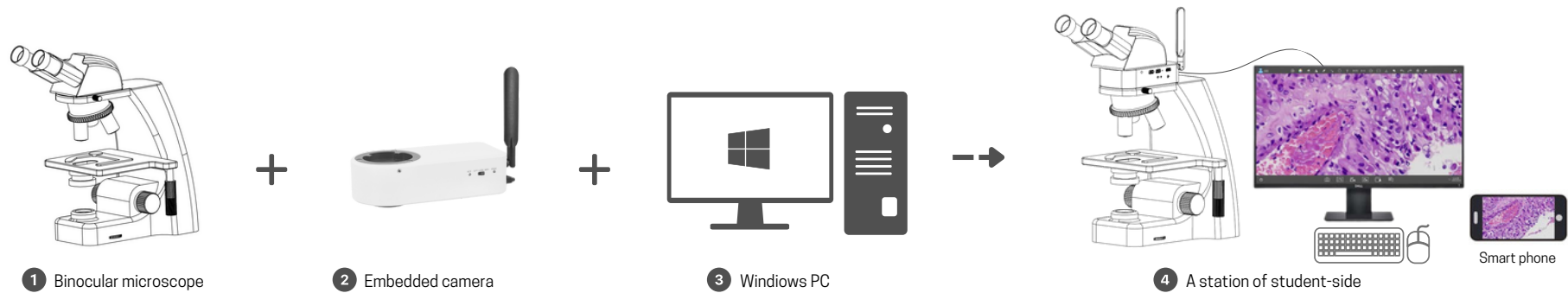

- ✓ Embedded with 50:50 splitting prism, without destroying the original optical system.
- ✓ Built-in high-power reduction lens for large field of view.
- ✓ Accurate and simple focusing with screw rod, to realize parfocality.
- ✓ Allows students to use their mobile phone or tablet to scan the dedicated seat QR code for wireless point-to-point connection to share live imaging.



All-in-one Smart Camera

Plan D uses an all-in-one smart microscope camera. The camera adopts dovetail mount or C-mount design which is compatible with trinocular microscopes from Olympus, Nikon, Leica and Zeiss. The camera comes with built-in operating system, the MS Office suite and microscope imaging software are pre-installed. The camera integrates a 15.6" full HD LCD display, which means that a student-station can be built without a dedicated computer and monitor. Each student-station only needs one power cord, no other cables. Plan A is easy to install, saves space and ensures a tidy tabletop. Read more about App for the student-station on page 16.

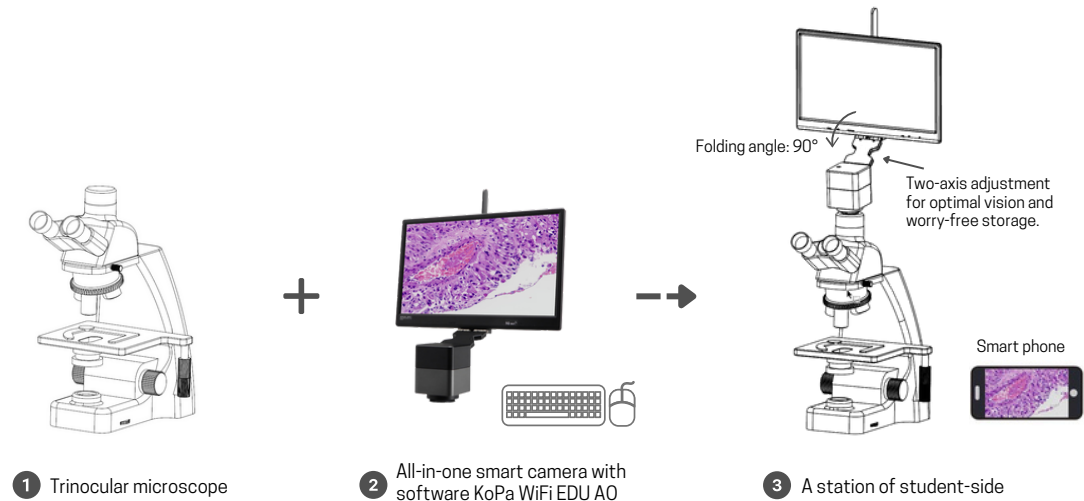

- ✓ The device is equipped with an all-in-one 15.6-inch with built-in deeply customized operating system. It comes with imaging APP, when starting up, it will connect with microscopic live image instantly and automatically.
- ✓ Built-in high-power reduction lens for large field of view.
- ✓ Accurate and simple focusing with screw rod, to realize parfocality.
- ✓ The USB ports can connect to mouse and keyboard, convenient for measuring, typing, and drawing.
- ✓ Supports HDMI out to monitor, TV, and projector.*
- ✓ Allows students to use their mobile phone or tablet to scan the dedicated seat QR code for wireless point-to-point connection to share live imaging.

* HDMI output is not available for all 20MP cameras (CMOS IMX147)

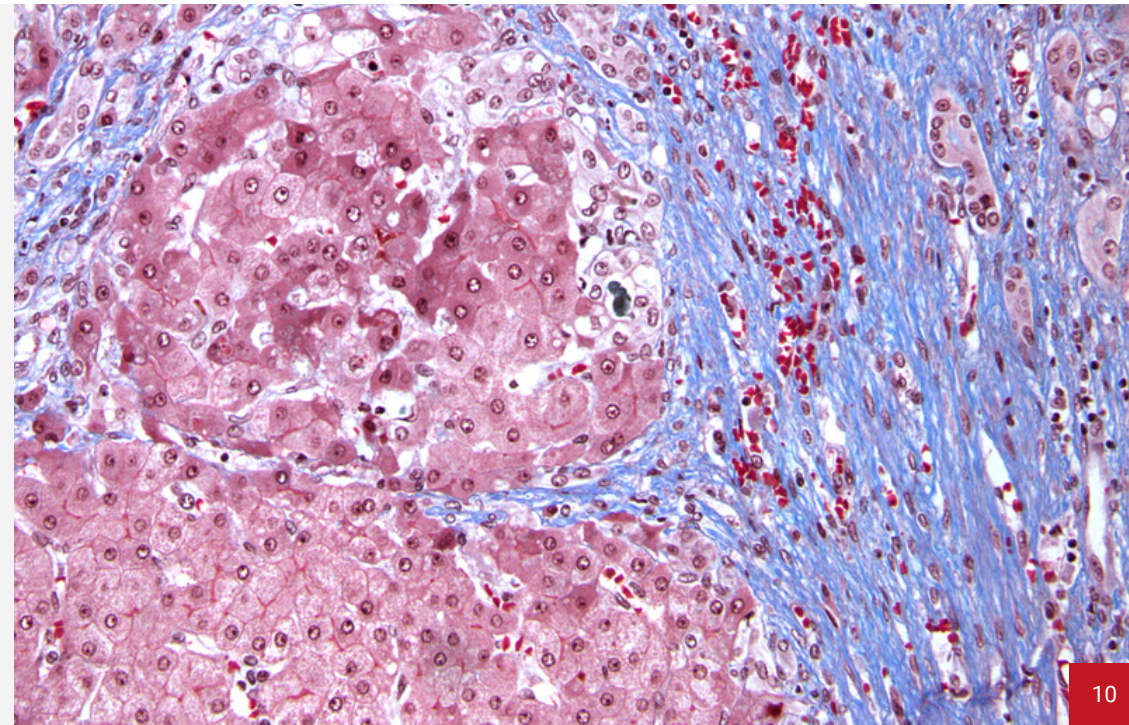

Embedded Smart Camera

Plan E uses a smart microscope camera. The camera adopts dovetail mount or C-mount design which is compatible with trinocular microscopes from Olympus, Nikon, Leica and Zeiss. The camera comes with built-in operating system, the MS Office suite and microscope imaging software are pre-installed. Only one monitor is required to build a student station. Read more about App for the student-station on page 16.

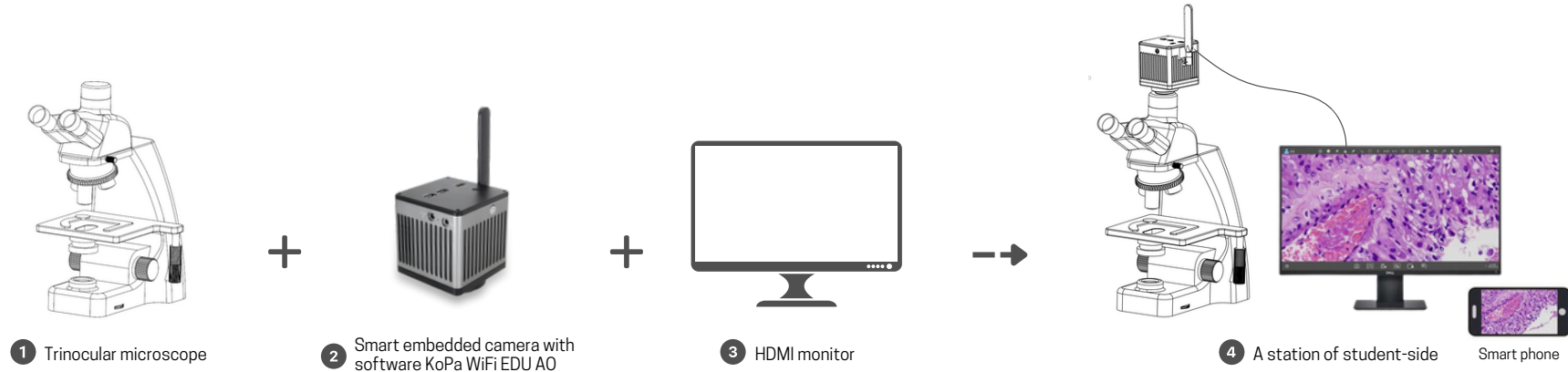

- ✓ The device is equipped with an all-in-one 15.6-inch with built-in deeply customized operating system. It comes with imaging APP, when starting up, it will connect with microscopic live image instantly and automatically.
- ✓ Embedded with 50:50 splitting prism, without destroying the original optical system.
- ✓ Built-in high-power reduction lens for large field of view.
- ✓ Accurate and simple focusing with screw rod, to realize parfocality.
- ✓ The USB ports can connect to mouse and keyboard, convenient for measuring, typing, and drawing.
- ✓ Supports HDMI out to monitor, TV, and projector. *
- ✓ Allows students to use their mobile phone or tablet to scan the dedicated seat QR code for wireless point-to-point connection to share live imaging.

* HDMI output is not available for all 20MP cameras (CMOS IMX147)



WiFi Camera

Plan F uses a WiFi microscope camera. The camera adopts dovetail mount or C-mount design which is compatible with trinocular microscopes from Olympus, Nikon, Leica and Zeiss. This plan supports Windows-based computers. On the premise of having a microscope with a WiFi embedded camera installed, the student-station only needs to be equipped with a computer and a monitor. Read more about software for the student-station on page 16.

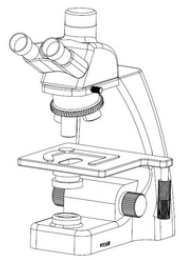

1 Trinocular microscope

+



2 WiFi Camera

+



3 Windows PC

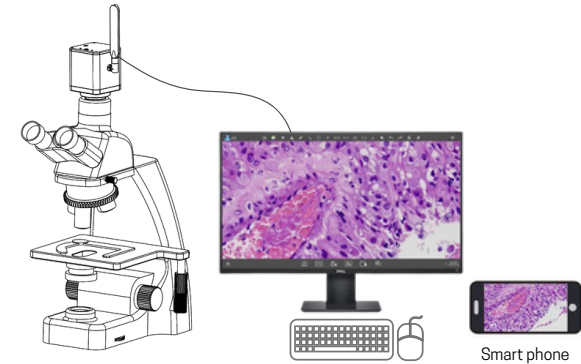

4 A station of student-side

Smart phone

- ✓ Embedded with 50:50 splitting prism, without destroying the original optical system.
- ✓ Built-in high-power reduction lens for large field of view.
- ✓ Accurate and simple focusing with screw rod, to realize parfocality.
- ✓ Allows students to use their mobile phone or tablet to scan the dedicated seat QR code for wireless point-to-point connection to share live imaging.



Specs of Student-side Cameras



All-in-one embedded smart camera

Plan A



Smart embedded camera

Plan B



Embedded WiFi camera

Plan C



All-in-one smart camera

Plan D



Smart camera

Plan E



WiFi Camera

Plan F

For binocular microscope

For trinocular microscope

Camera Models & Specs

Applicable microscope	Olympus	Nikon	Leica	Zeiss	Olympus	Nikon	Leica	Zeiss
① Plan A	HE2010-MX	HE2010-MN	HE2010-ML	HE2010-MZ	HE1210-MX	HE1210-MN	HE1210-ML	HE1210-MZ
② Plan B	TE2000-MX	TE2000-MN	TE2000-ML	TE2000-MZ	TE1200-MX	TE1200-MN	TE1200-ML	TE1210-MZ
③ Plan C	CA2010-MX	CA2010-MN	CA2010-ML	CA2010-MZ	CA1210-MX	CA1210-MN	CA1210-ML	CA1210-MZ
④ Plan D *	JX2000-MX	JX2000-MN	JX2000-ML	JX2000-MZ	JX1200-MX	JX1200-MN	JX1200-ML	JX1200-MZ
⑤ Plan E *	HW2000-MX	HW2000-MN	HW2000-ML	HW2000-MZ	HW1200-MX	HW1200-MN	HW1200-ML	HW1200-MZ
⑥ Plan F *	HD2000-MX	HD2000-MN	HD2000-ML	HD2000-MZ	HD1200-MX	HD1200-MN	HD1200-ML	HD1200-MZ
Resolution	20 MP (5184x3888 pixels)				12 MP (4000x3000 pixels)			
Image sensor	Sony IMX147 CMOS				Sony IMX412 CMOS			
Shutter type	Electronic rolling				Electronic rolling			
Sensor size	1/1.2.3"				1/2.3"			
Pixel size	1.2µm x 1.2µm				1.55µm x 1.55 µm			
Spectral response	380~650nm				380~650nm			
Exposure	Real-time automatic, manual adjustment				Real-time automatic, manual adjustment			
White balance	Real-time automatic, manual adjustment				Real-time automatic, manual adjustment			
Preview resolution	10fps: 5184x3888; 15fps: 3840x2160				30fps: 4000x3000, 3840x2160, 2592x1944, 1920x1080			
Record format	Snapshot: JPG, BMP, PNG, TIFF, PDF Resolution: 5184x3888, 3840x2160 Record: MP4 file Resolution: up to 25fps @ 1920x1080				Snapshot: JPG, BMP, PNG, TIFF, PDF Resolution: 4000x3000, 3840x2160, 2592x1944, 1920x1080 Record: MP4 file Resolution: up to 25fps @ 1920x1080			

* Cameras equipped with C mount are not listed in this table.

Pixit WiFi EDU

Lecturing Mode

The tutor PC screen or the selected student smart device screen is streamed to all student smart devices synchronously. Lecture materials in Word \ Excel \ PPT are displayed on the smart device of students in real time to enrich the teaching content. The operation process of the tutor PC or the selected student smart device is displayed to all student smart devices synchronously.

Messenger

Tutor can communicate with students using text or picture; and one click to collect all students' images under microscopes. Tutor can choose any or all students within the system network to distribute homework (support word, Excel, PPT, picture file etc.) The messenger can be used for voice based chat between tutor and students to achieve one-to-one guidance.

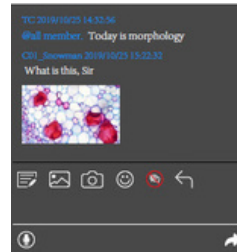

Monitor Station-Screen

Real-time monitoring of all screens of student-stations to ensure that all students participate in learning. Without the tutor's permission, the students' all-in-one smart camera cannot install any App, nor can it exit the current teaching App.

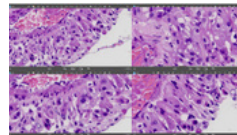

Monitor Microscopic Image

All student images are automatically displayed on the PC software of the tutor. Tutor can confirm whether the students correctly understand the experimental intentions through the images. Tutor can even control the attributes of student images, to guide students correctly, and even take pictures and videos of the instruction process

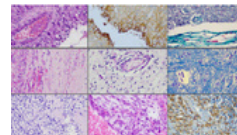

Comparison Mode

The tutor's screen can display any two or four student images for analysis and comparison, supporting static image comparison, dynamic image comparison, static and dynamic mixed comparison, supporting tutor side and selected student side comparison.

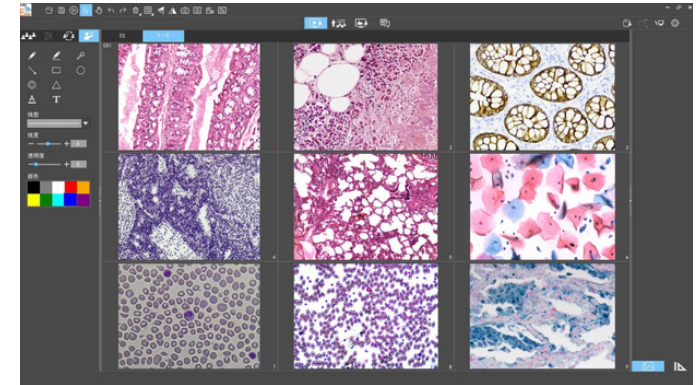
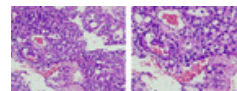

Online Attendance Checking

Quickly check the boot status and login status of the student terminal to investigate electronic attendance. One-click to generate a list of attendance.

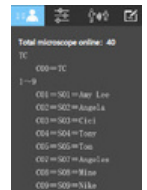

Annotation Tools

Excellent students' works can be sent to other students as an example together with tutors' annotations

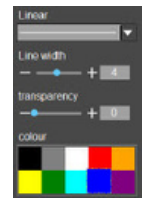

Whiteboard Mode

Whiteboard tools include Pen, Arrow, Text, Undo, Redo, Eraser, Delete, Object editing, Macro photography, Macro video, Mouse penetration, etc. In the lecturing mode, it helps the teacher to annotate and send real-time courseware, videos to all student-stations.

Hardware Requirements

Operating System	CPU	RAM	ROM	Graphic Card	Network Card
Windows 10 64bit	i7 8th-generation or later version	512 GB or more	16 GB or more	Discrete graphics (NVIDIA GeForce)	10/100/1000M Self-adaptive

Tools in EDU Software

Common Tools

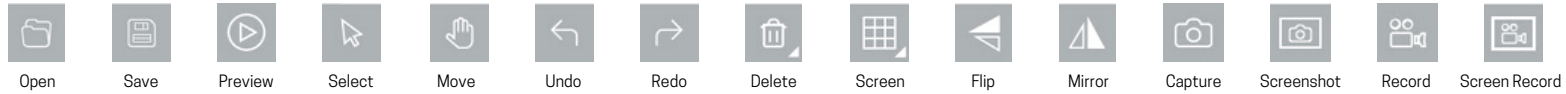

Measuring Tools

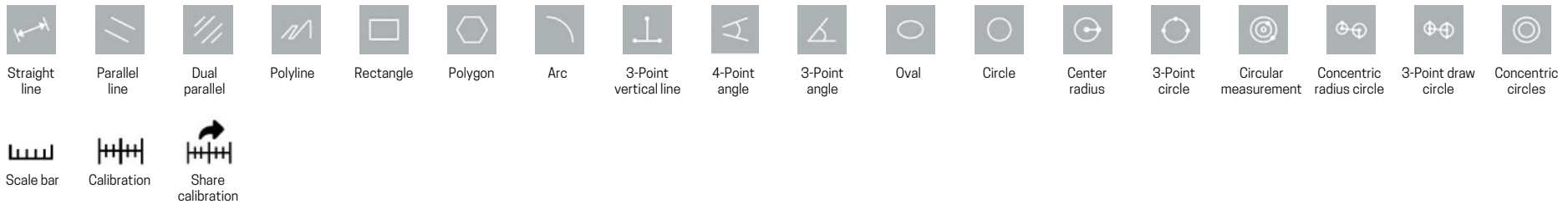

Interaction Settings

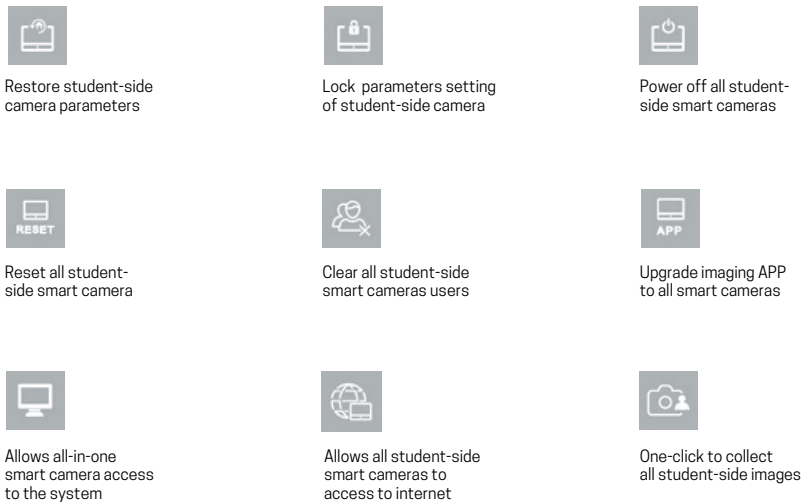

Camera Settings



Monitoring-Window Tab



Each tab displays 9 grids of screen real-time images from student-stations, double-clicking a specific screen can make it display in full-size.

System Settings



Export Tools

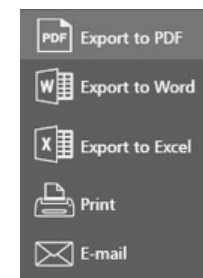

Imaging APP for Student-side Camera

Pixit WiFi EDU A0

User Login

User login interface. Need or no need to log in, it depends on the settings on the tutor-side EDU software. If it is set to require login, then the user needs to fill in the corresponding username or ID. During use, it is allowed to switch user or to create new user. When multiple users share a station, they can submit assignments sequentially by switching users. It will automatically generate a folder according to the username in the storage path of the teacher's computer.

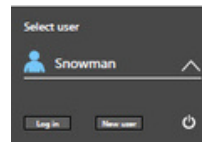

Messenger

The tool for instant communication between tutor and student, using text, picture, and voice. Students can capture live image and send to the tutor or withdraw the wrong message by one-click.

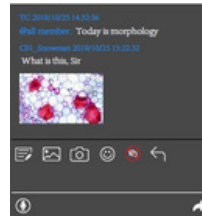

Common Tools

Pictures, videos, and assignments can be transmitted to the tutor's PC in one click, and the Word \ Excel \ PPT format assignment can be edited and uploaded to tutor's PC.



Assignment Tools

Assignment in format of Word, Excel, PPT can be edited and sent along with picture and video to the tutor's PC.



Taskbar

- U-Disk access status
- Current input method
- Connection status

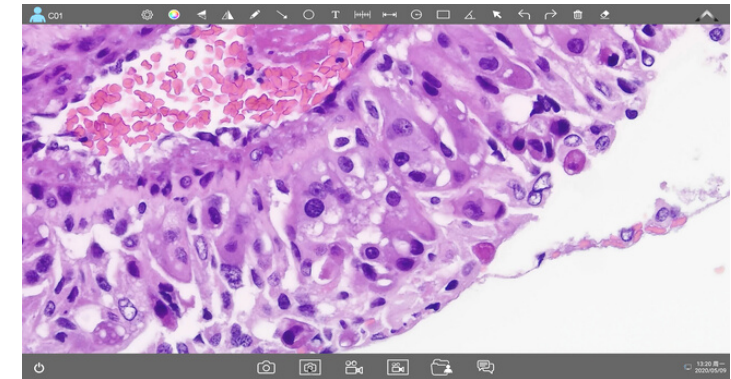

Measurement & Annotation

For specific microscope models (Olympus CX23 and Nikon Ei), 4x, 10x, 40x, and 100x objectives have been calibrated, and the calibration data has been saved in the software. It is not required to calibrate if using Olympus CX23 or Nikon Ei.



Camera Settings

The camera attributes of each station can be adjusted, including brightness, contrast, saturation, exposure time, white balance, etc. The tutor can also share camera attributes to all stations from tutor-side EDU software, or restrict camera settings on student-stations.



Preference Settings

Users can set preferences such as language, brightness, sound, video duration, scalebar type, restore factory settings, etc. With the authorization of the system administrator, the user can access to the Internet or enter the system desktop on this panel.

KoPa WiFi EDU



i When the system uses Plan 1, Plan 2, or Plan 3 in student stations, some functions of this App are not applicable. The mobile devices can only see the live microscopic image of the station but not have the functions of interaction. Please consult the manufacturer for more information.

Hardware Requirements

System	System version	CPU	Storage	Graphic Card	Protocol
Android	7.0 or later version	Dual-core 1.7GHz or better	At least 3GB	32GB or more	5G WiFi IEEE 802.11ac
iOS	11.0 or later version	Dual-core 1.8GHz or better	At least 2GB	32GB or more	



Accessories in the Box

Interactive Workstation (Tutor-station)



Allen key (3mm)
(Only for dovetail-mount cameras)



Power Adapter and Power Cord



Dust Cover for Microscope
40x59x40 cm, Oxford cloth



Gigabit Ethernet cable (2 meters)

Student-station



Allen key (3mm)
(Only for dovetail-mount cameras)



Power Adapter and Power Cord



Dust Cover for Microscope
40x59x40 cm, Oxford cloth



Gigabit Ethernet cable (2 meters)



Keyboard & Mouse Suite
(Only for Plan A & Plan B)



USB - DC power cord
(Only for Plan A, Plan B & Plan C)

Dimensions 1

Unit: mm

Interactive Workstation

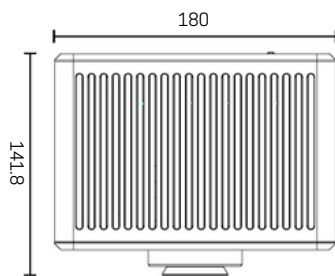
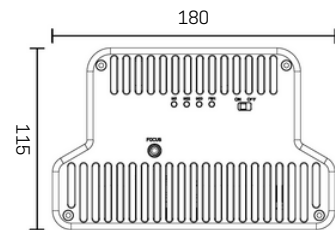

Dovetail mount

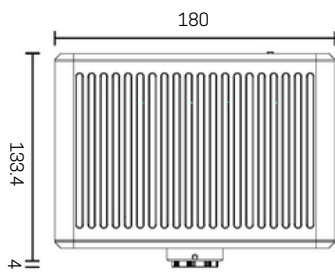

C mount

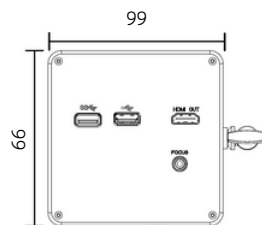

Dovetail mount

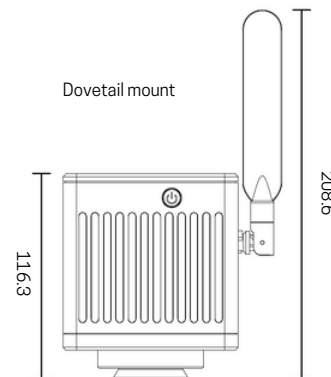

C mount

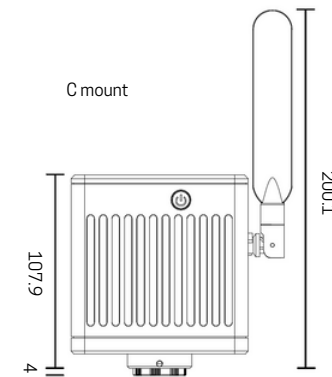

Smart Camera

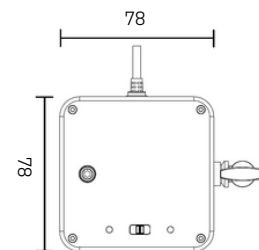

Dovetail mount

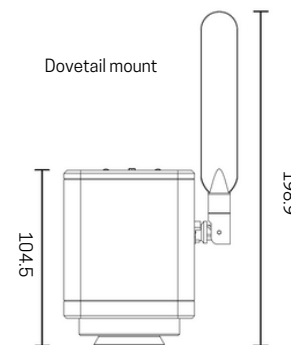

C mount

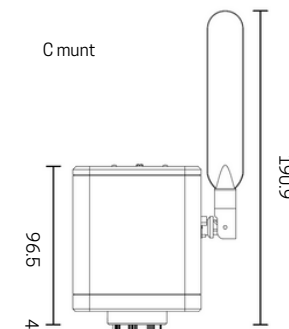

WiFi Camera

Dimensions 2

Unit: mm

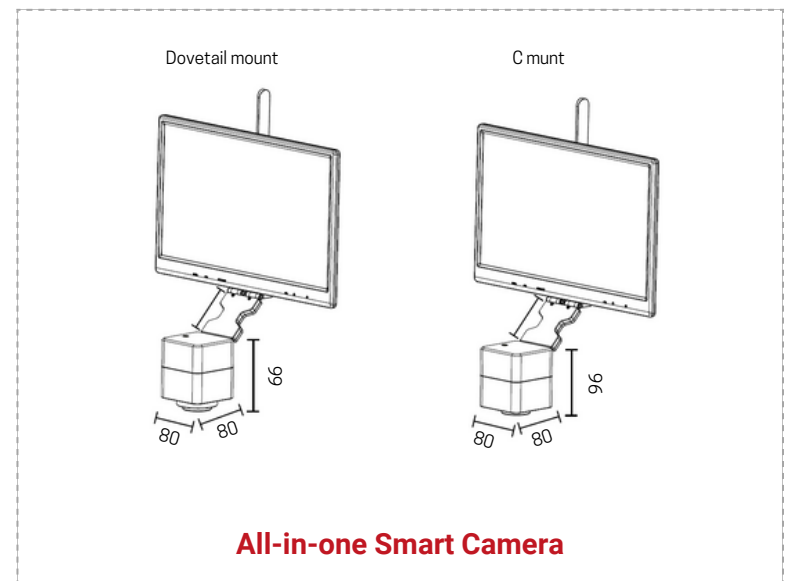
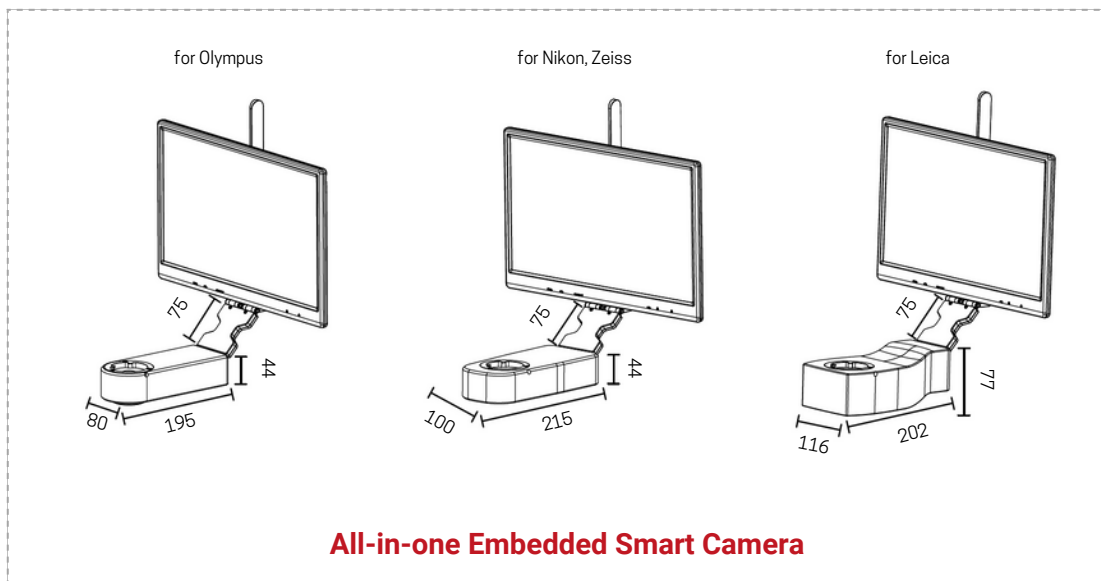
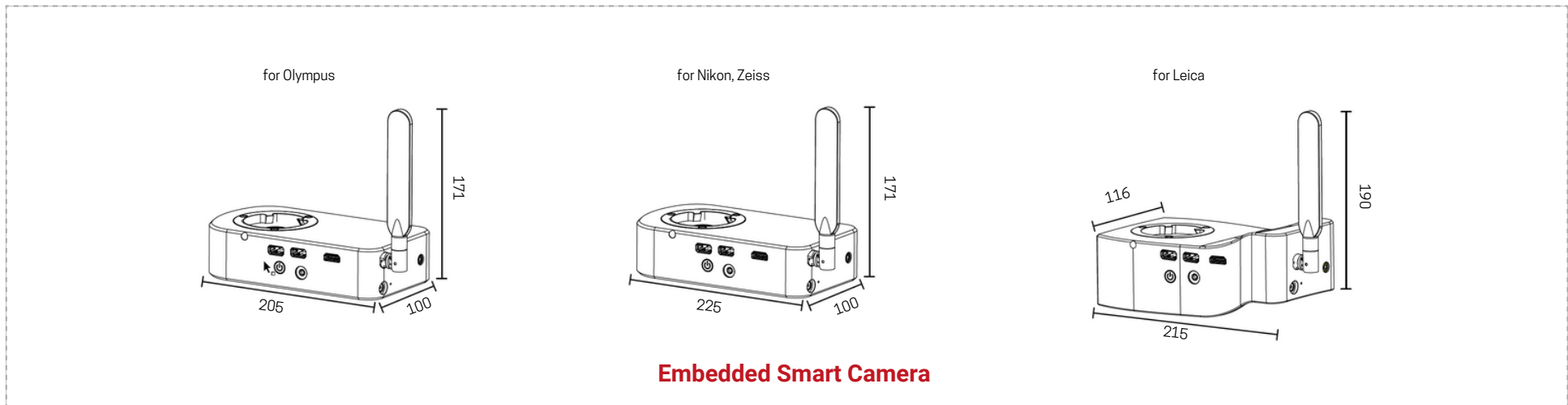



LANOPTIK TECHNOLOGIES LTD (CHINA)

72 Hongjing Str., Lejia Rd., Baiyun Dist.,
Guangzhou 510400, China
+86 20 3898 6017
info@lanoptik.com
www.lanoptik.com

NAHWOO PRECISION CO. (SOUTH KOREA)

104 Trebo Officetel, 26-25 Uman-dong,
Paldal-gu, Suwon, South Korea 442-8169
+82 31 893-8228
iWorks@nahwoo.co.kr
www.nahwoo.com

